

ULTRADESK®

SPACE

BK

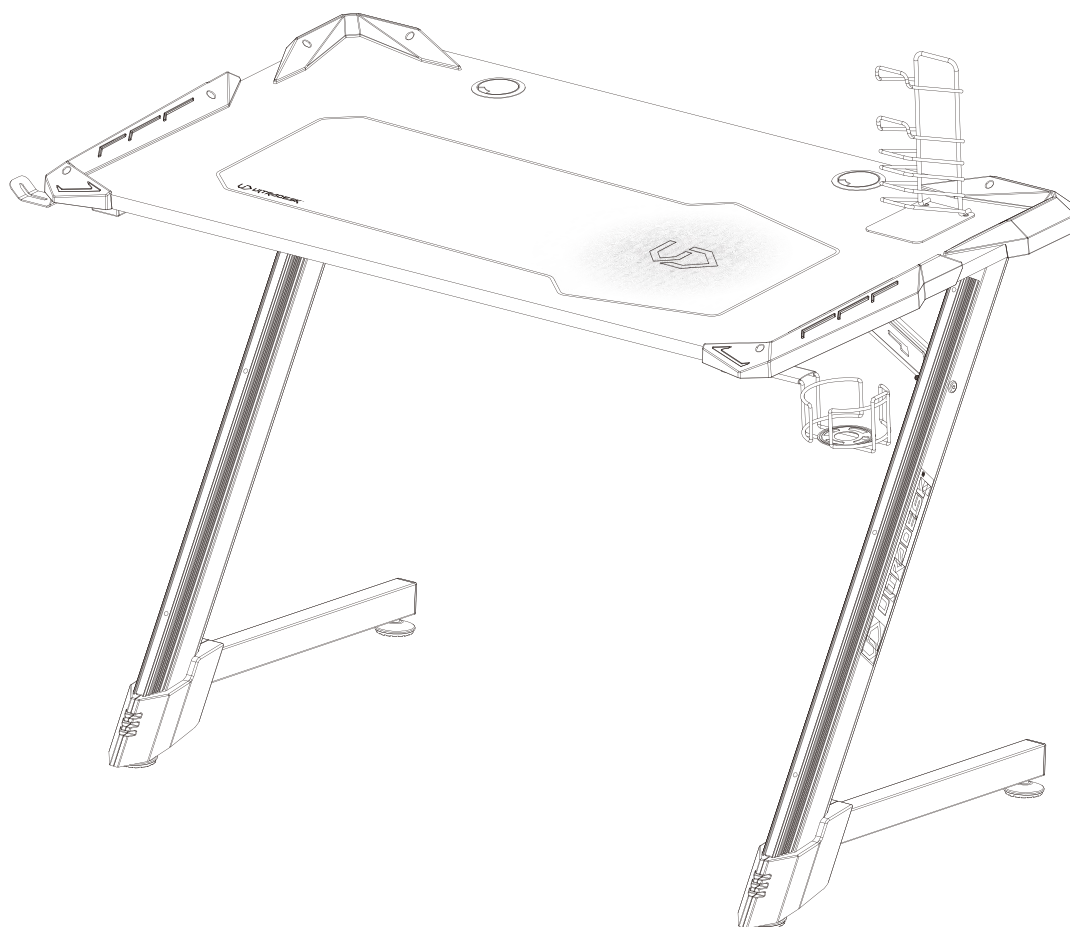

ASSEMBLY INSTRUCTIONS
ANLEITUNG
INSTRUKCJA
NÁVOD K SESTAVENÍ
NÁVOD NA ZOSTAVENIE

① ② ③ ④ ⑤ ⑥ ⑦ ⑧ ⑨ ⑩

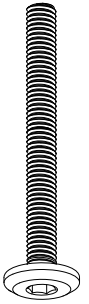

X6



X6



X2

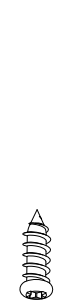

X8

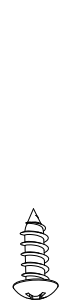

X6

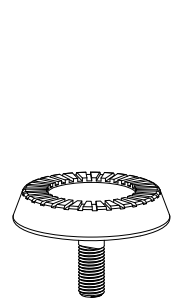

X4



X2



X4

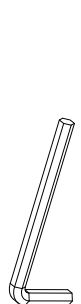

X1

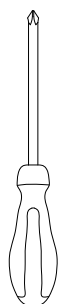

X1

P1

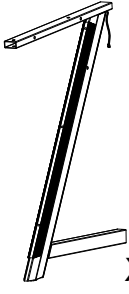

X1

P2

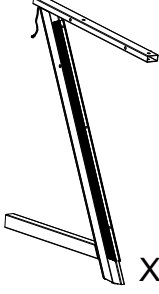

X1

P3

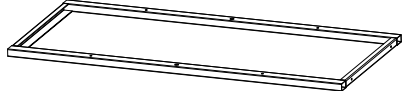

X1

P4

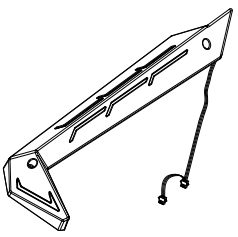

X1

P5

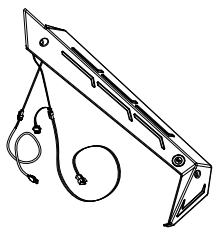

X1

P6

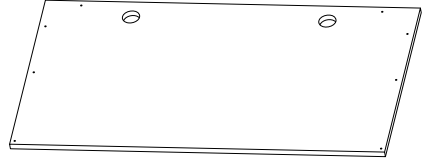

X1

P7

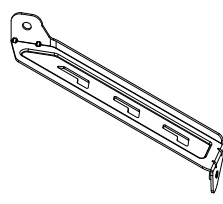

X1

P8

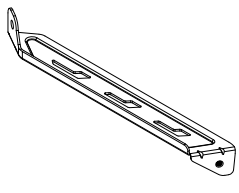

X1

P9

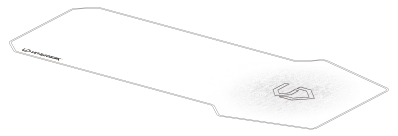

X1

P10

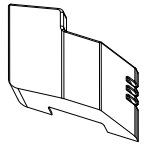

X2

P11

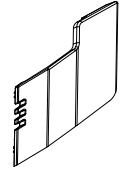

X2

P12

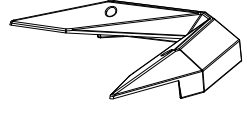

X2

P13

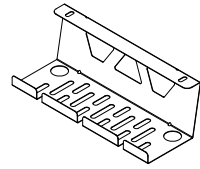

X1

P14



X2

P15

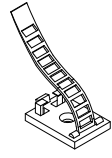

X4

P16

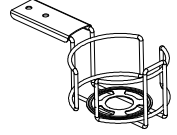

X1

P17

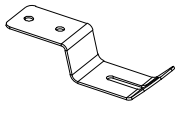

X1

P18

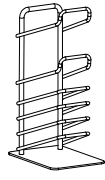

X1





P19

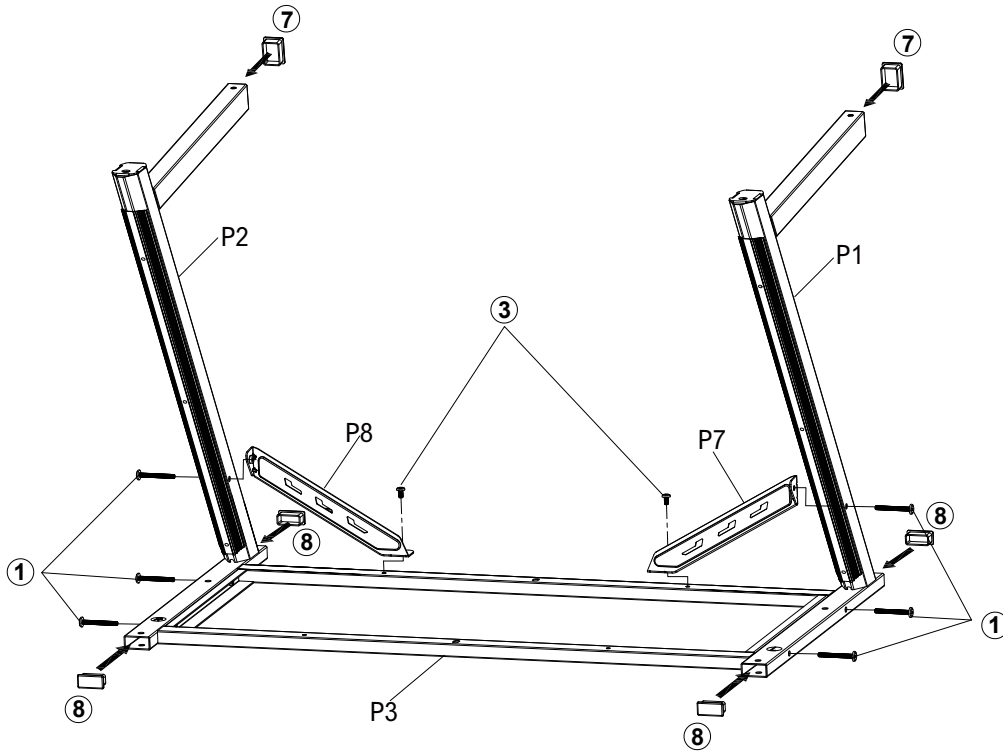

X2

1.



- 1**  x 6
- 3**  x 2
- 7**  x 2
- 8**  x 4

2.

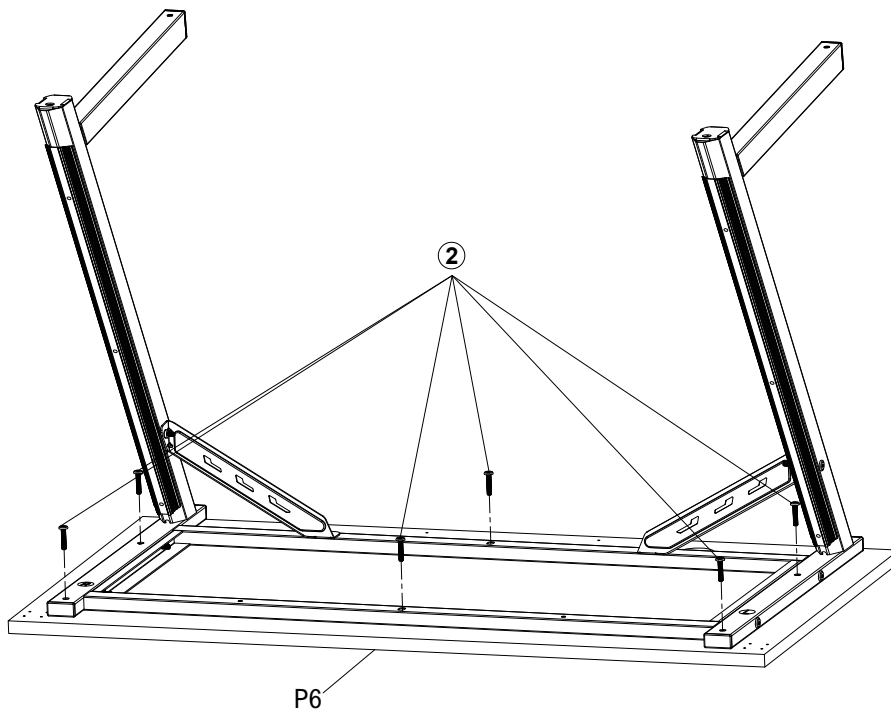

- 2**  x 6

3.

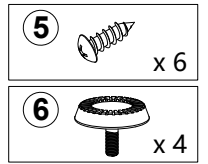
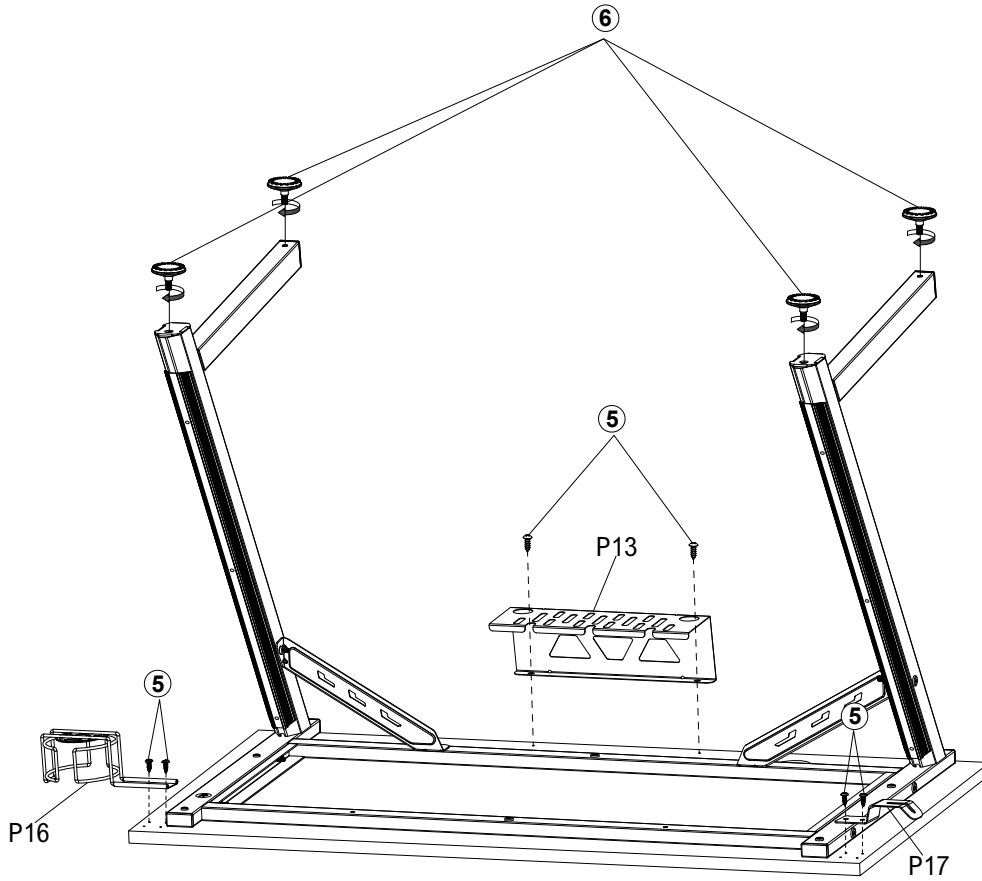

4.

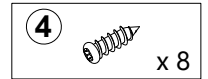
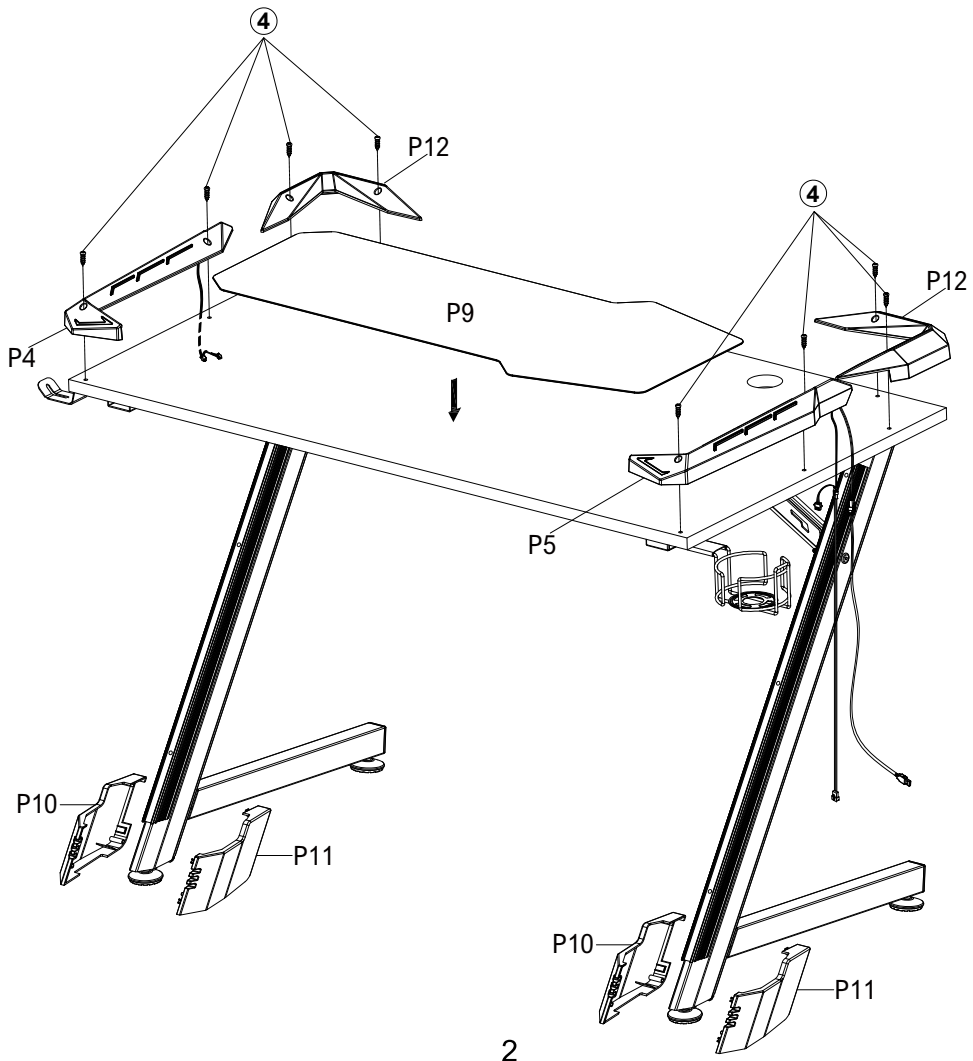

5.

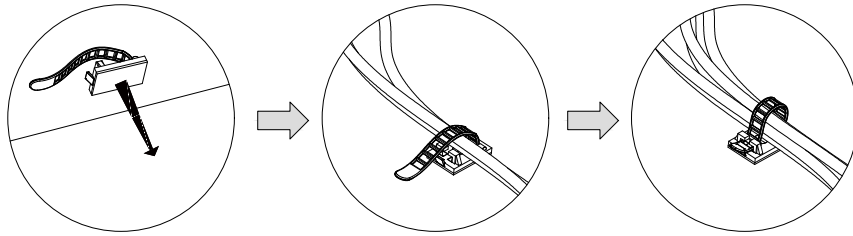

STICK
KLEBEN
PRZYKLEJ
PŘILEPIT
PRILEPIT

CLICK!
KLICK!
KLIK!

P15  x 4

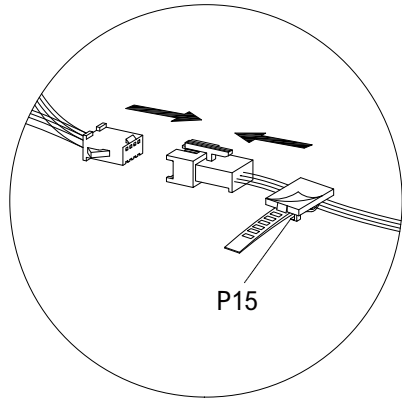

P15

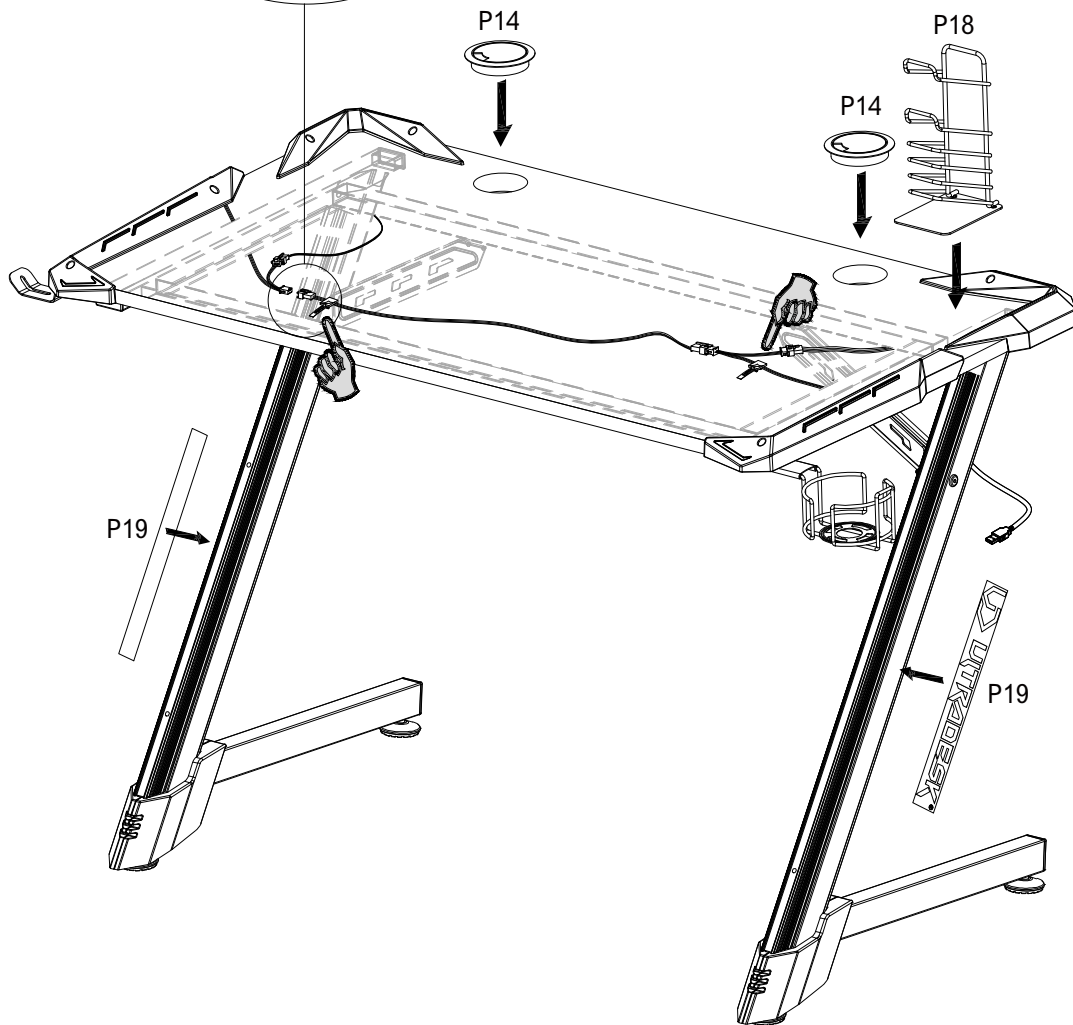

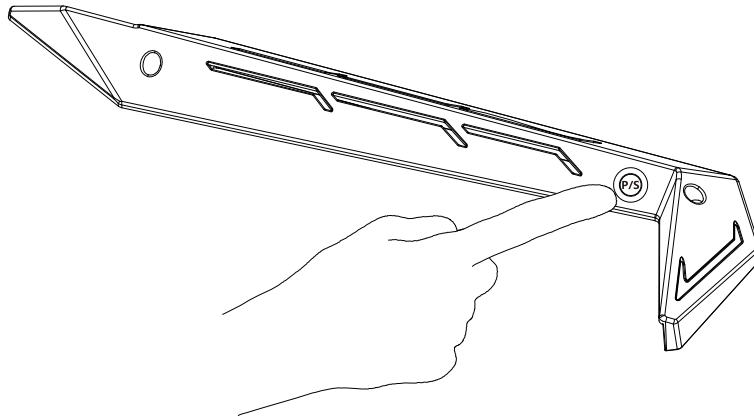

MAIN TECHNICAL PARAMETERS					
Parameters	Min	Normal	Max	Test Condition	Unit
Rated voltage(DC)	4.45	5	5.20		V
Rated power		1.50			W
Maximum power		1.65			W
Maximum current		330			mA
Environment temperature	-20		60		°C

FUNCTION

1. Changing Lighting Modes: Make sure the desk light is on, then press the right button "Ⓟ" to change modes. There are total 8 lighting modes.
2. Switching On/Off Lights: Press the button "Ⓟ" for 3 seconds then the light will be off. If want to switch on the light, just repeat the operation.

TROUBLE SHOOTING

1. When the light flashes unexpectedly, please try to reboot it (turn it off and then on). If a reboot doesn't work, please check if the adapter work normally.
2. If the light isn't on, please check if the power is on, or all the cables are connected correctly and tightly.

TECHNISCHE PARAMETER					
Parameter	Min	Normal	Max	Test	Einheit
Nennspannung (DC)	4.45	5	5.20		V
Nennleistung		1.50			W
Maximale Leistung		1.65			W
Maximalstrom		330			mA
Umgebungstemperatur	-20		60		°C

FUNKTIONEN

1. Wechsel der Beleuchtung Modis: schalte die LEDs ein, drücke die rechte Taste "Ⓟ", um den Modus zu wechseln. Es gibt 8 verschiedene Modis.
2. Ein- und Ausschalten der Beleuchtung: drücke die Taste "Ⓟ" für 3 Sekunden, um die Beleuchtung einzuschalten. Drücke diese Taste wieder für 3 Sekunden, um die Beleuchtung auszuschalten.

PROBLEMLÖSUNG

1. Wenn die Beleuchtung plötzlich anfängt zu blinken, bitte schalte sie wieder aus und ein. Bleibt das Problem ungelöst, prüfe die Stromversorgung.
2. Wenn keine Dioden leuchten, prüfe die Stromversorgung und die Verbindungen von alien Kabeln.

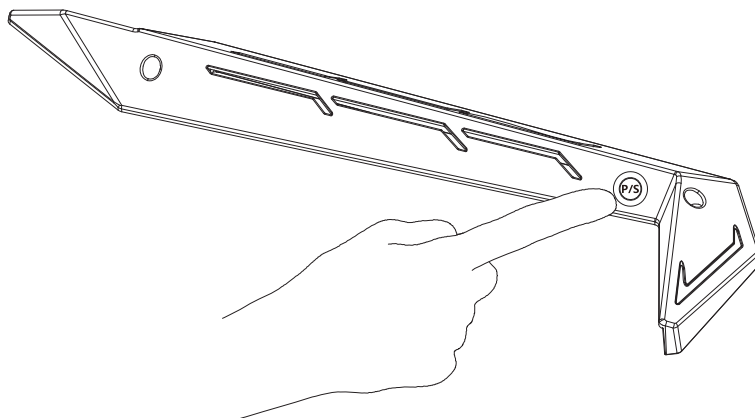

PARAMETRY TECHNICZNE					
Parametr	Min	Normal	Max	Test	Jednotka
Napięcie znamionowe (DC)	4.45	5	5.20		V
Moc znamionowa		1.50			W
Moc maksymalna		1.65			W
Maksymalne obciążenie		330			mA
Temperatura otoczenia	-20		60		°C

FUNKCJE

1. Zmiana trybu podświetlenia: włącz podświetlenie, naciśnij krótko prawy przycisk “

ROZWIĄZYWANIE PROBLEMÓW

1. Jeśli podświetlenie zacznie nagle pulsować, wyłącz i włącz je ponownie oraz sprawdź źródło zasilania.
2. Jeśli diody LED nie świecą, sprawdź źródło zasilania oraz wszystkie połączenia kabli.

HLAVNÍ TECHNICKÉ PARAMETRY					
Parametry	Min	Normal	Max	Podmínky testování	Jednotka
Jmenovité napětí (DC)	4.45	5	5.20		V
Jmenovitý výkon		1.50			W
Maximální výkon		1.65			W
Maximální proud		330			mA
Teplota prostředí	-20		60		°C

FUNKCE

1. Změna režimu podsvícení: Ujistěte se prvně, že je podsvícení stolu zapnuté, poté klikněte pravé tlačítko “

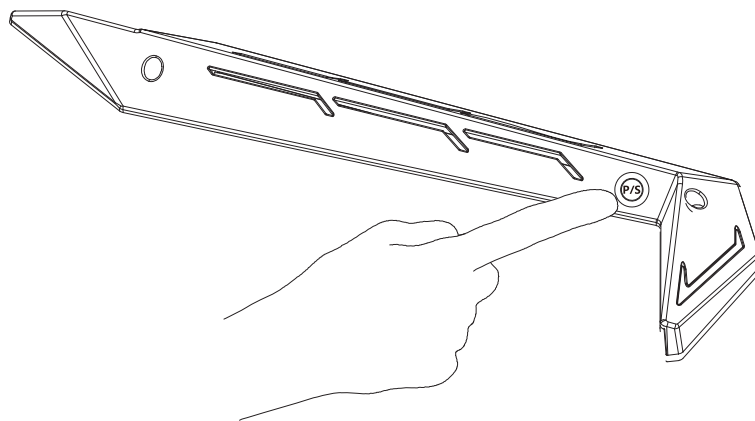

ŘEŠENÍ POTÍŽÍ

1. Pokud bude podsvícení neobvykle blikat, vypněte a opět zapněte podsvícení stolu. Pokud opětovné vypnutí a zapnutí problém nevyřešilo, ujistěte se, že adaptér funguje správně.
2. Pokud podsvícení nesvítí, ujistěte se, že je zapnuté, že máte přísun elektrické energie do adaptéru nebo jestli jsou všechny kabely řádně zapojeny.



HLAVNÉ TECHNICKÉ PARAMETRE					
Paramtere	Min	Normal	Max	Podmienky testovania	Jednotka
Menovité napätie (DC)	4.45	5	5.20		V
Menovitý výkon		1.50			W
Maximálny výkon		1.65			W
Maximálny prúd		330			mA
Teplota prostredia	-20		60		°C

FUNKCIE

1. Zmena režimu podsvietenia: Najskôr sa uistite, či je podsvietenie stola zapnuté, potom kliknite na pravé tlačidlo “” pre zmenu režimu podsvietenia. Je možné si vybrať medzi 8 režimami podsvietenia.
2. Zapnutie/vypnutie podsvietenia: Stlačte tlačidlo “” po dobu 3 sekúnd a podsvietenie sa vypne. Ak si prajete podsvietenie opäť zapnúť, opakujte proces.

RIEŠENIE PROBLÉMOV

1. Ak bude podsvietenie neobvykle blikať, vypnite a opäť zapnite podsvietenie stola. Ak opätovné vypnutie a zapnutie problém nevyriešilo, uistite sa, či adaptér funguje správne.
2. Ak podsvietenie nesvieti, uistite sa, že je zapnuté, že máte prísun elektrickej energie do adaptéra alebo či sú všetky káble riadne zapojené.